



E I C H H O L T Z

113307 CHANDELIER HILDEBRANDT

ASSEMBLY INSTRUCTION

1 Remove the plywood cross bars from the front and back of the carton.

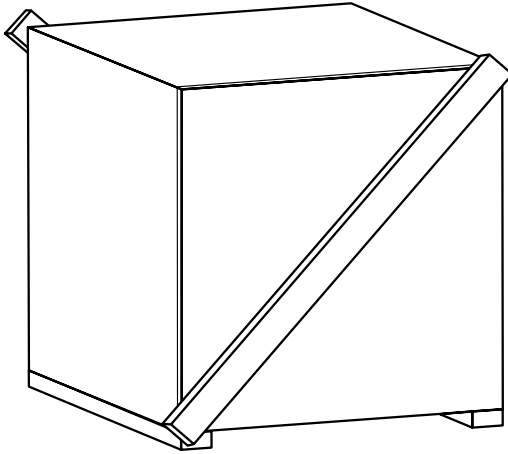

ZOOM

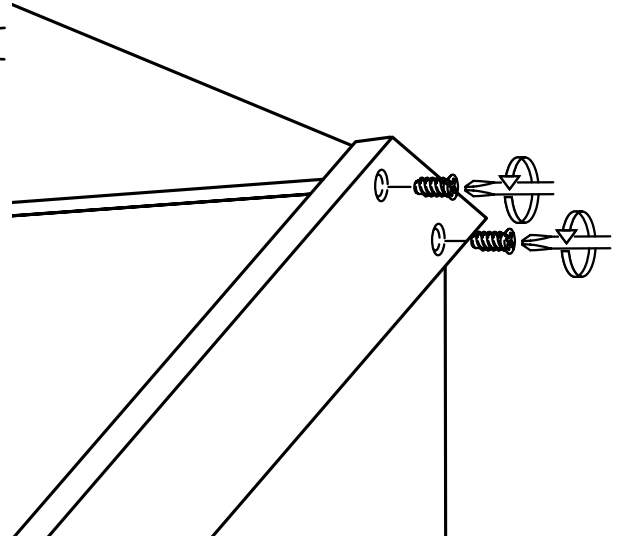

2 Cut the tape and remove the carton sheets.

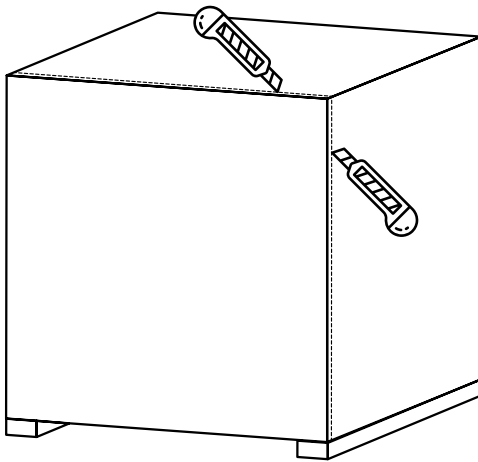

ZOOM

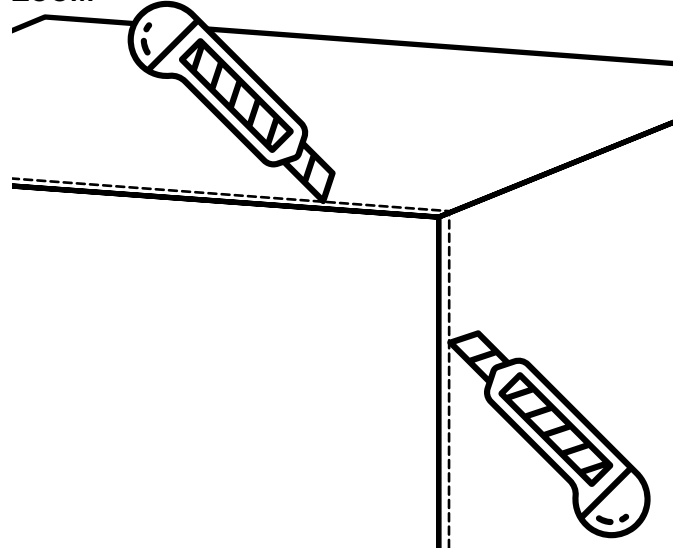

3 Cut the plastic straps and remove the box with the ceiling fixtures.

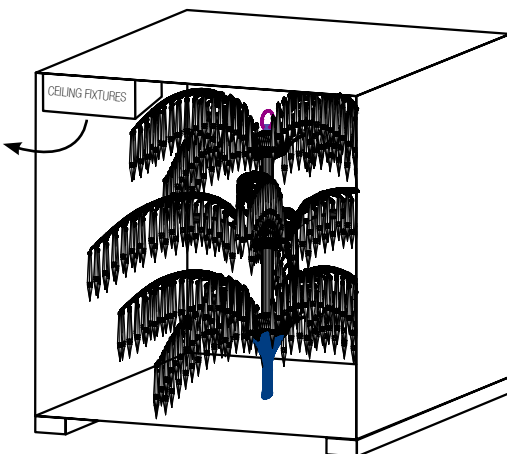

4 Follow the instructions on page 2 so the chandelier can be hung directly from the crate to the ceiling without placing it on the ground.

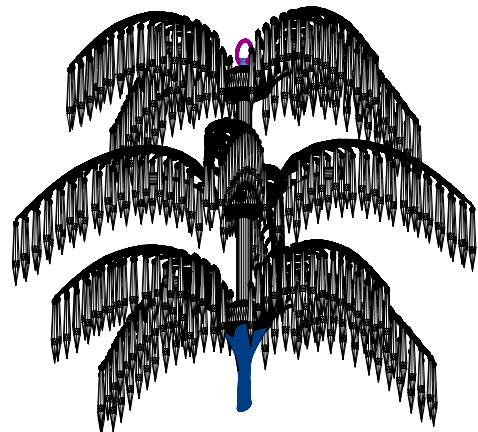



E I C H H O L T Z

113307 CHANDELIER HILDEBRANDT

ASSEMBLY INSTRUCTION

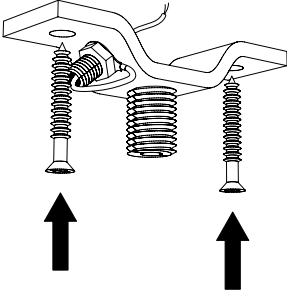
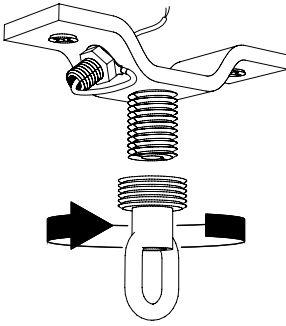
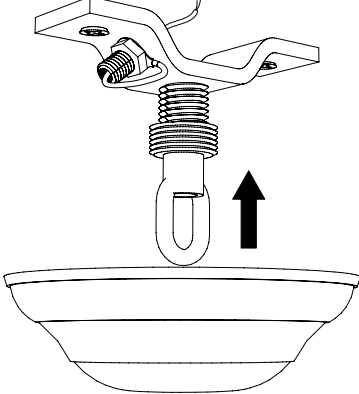
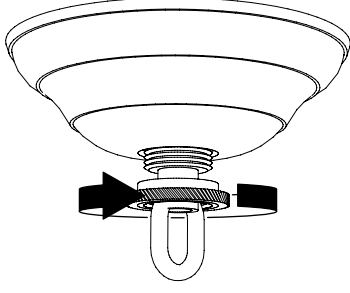
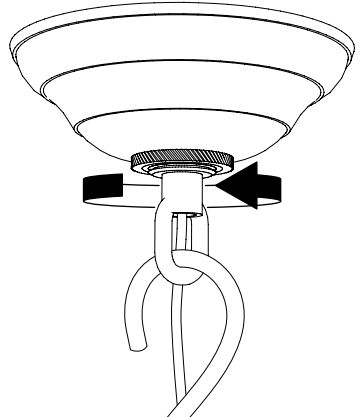
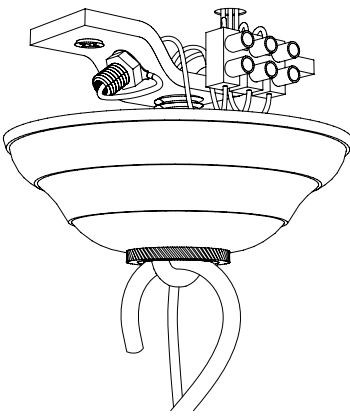
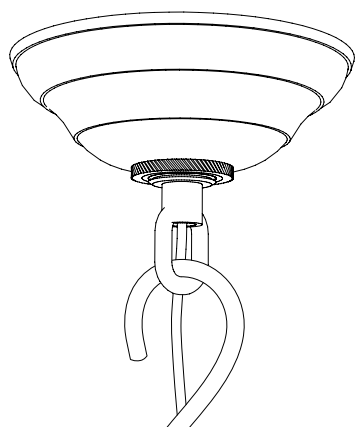
<p>5</p> 	<p>6</p> 
<p>7</p> 	<p>8</p> 
<p>9</p> 	<p>10</p> 
<p>11</p> 	<p>This product is for indoor use only. Outdoor use could result in shock, fire or serious bodily injury or death. All wiring must be done in accordance with national and local electric codes. It is strongly recommended that you use a qualified electrician.</p> <p>Turn-off the electricity supply at the main circuit panel before installing. Do not connect the electricity supply until your lamp is fully assembled and installed.</p> <p>Fix the ceiling bracket to the ceiling by using mounting plugs and screws suitable to your ceiling type and take into account the weight of your luminaire.</p> <p>Connect the 3 power wires according to their colours. Brown is the live wire, blue is the neutral wire, the green yellow wire is the earthwire.</p>