



E I C H H O L T Z

111043 CHANDELIER SALASCO

ASSEMBLY INSTRUCTION

- 1** Determine the desired height of your chandelier and connect the extension pipes. Thread the wire from the lamp through the pipe.

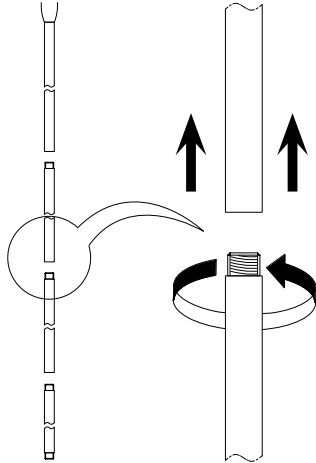

- 2** Pull the steel wire through the pipes and the ceiling plate and fix it with the wire lock.

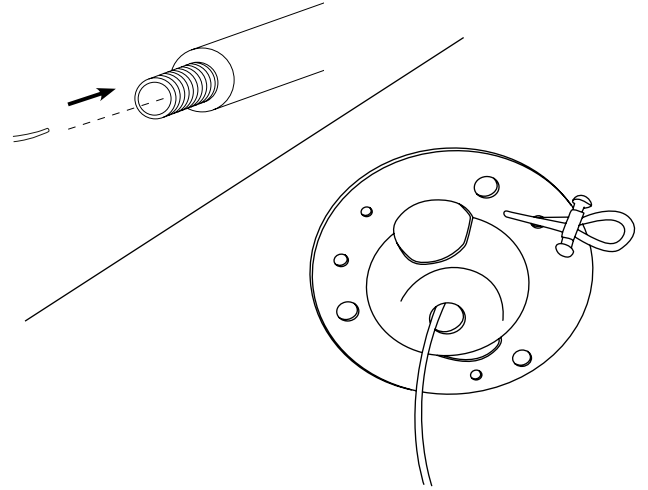

- 3** Fix the ceiling plate (A) to the ceiling by using mounting plugs and screws suitable to your ceiling type. Guide the wires through the plate. Place or hold the lamp in an elevated position in such a way that the wires can freely reach the ceiling junction box. Connect the 3 power wires according to their colours. Brown is the live wire, blue is the neutral wire, green/yellow is the earth wire. Place the ceiling canopy (B) flush against the ceiling and fix it securely with the two nuts supplied.

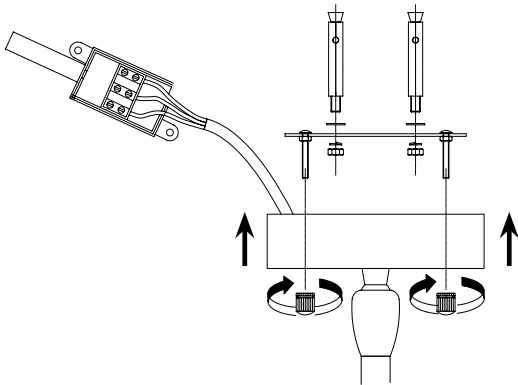

- 4** Balance the luminaire and slide a crystal shade over a lampholder. Use the 'V' shape wrench (included) to tighten the ring on the lamp holder. Repeat for each shade. Place the bulbs.

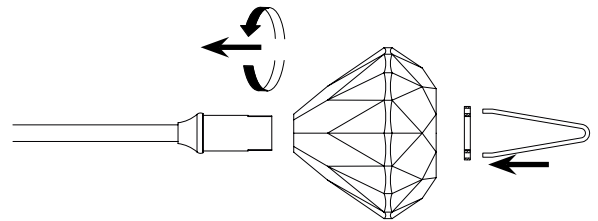

FINAL

